

INSTALLATION INSTRUCTIONS FOR SENSOR UR UNIVERSAL VALVE

SLOAN®

Model -SGV-7900

SKU Description-SVG7900 Sensor UR Universal Valve

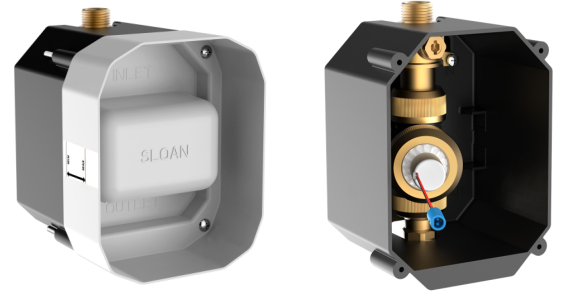

INSIDE THE BOX & IMPORTANT

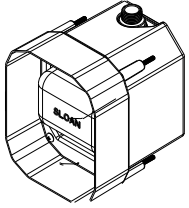

1. Concealed valve asm



2. Installation Instruction

RECOMMENDED TOOLS

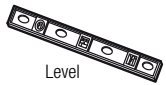

Level



Phillips Screwdriver



Tape Measure

Important:

- ALL ELECTRICAL WIRING IS TO BE INSTALLED IN ACCORDANCE WITH NATIONAL/LOCAL CODES AND REGULATIONS.
- ALL PLUMBING IS TO BE INSTALLED IN ACCORDANCE WITH APPLICABLE CODES AND REGULATIONS.
- SLOAN URINAL VALVE IS DESIGNED TO OPERATE WITH 0.7 TO 5.5 BAR OF WATER PRESSURE .
- WATER SUPPLY LINES MUST BE SIZED TO PROVIDE AN ADEQUATE VOLUME OF WATER FOR EACH FIXTURE.
- FLUSH ALL WATER LINES PRIOR TO MAKING CONNECTIONS.
- KEEP THREAD SEALANT OUT OF YOUR WATERWAY TO PREVENT COMPONENT PARTT DAMAGE! DO NOT APP Y SEALANT TO THE FIRST TWO "STARTER" THREADS.
- WHEN OPTIONAL TRANSFORMER IS USED — A 6 VAC STEP-DOWN TRANSFORMER MUST BE USED
- USE APPROPRIATE PRECAUTIONS WHILE CONNECTING TRANSFORMER TO 220 VAC POWER SOURCE-Sloan ELG-220(220VAC/ 6VAC(Transformer not provided)

PRIOR TO INSTALLATION

Prior to installing the Sloan Flush Valve, install the items listed below as illustrated in the rough-in diagrams below.

- Urinal fixture drain line & Water supply line
- When hardwired option is used than wire pipe line must be installed .
- This valve is designed for new construction or where there is easily accessed plumbing for the fixture and the valve.This valve is designed for minimum six inch (153 mm) wall space depth ,Wall opening must be 160 mm x 119 mm. Mud gaurd is provided and must accompany valve for proper installation.

ROUGHING-IN

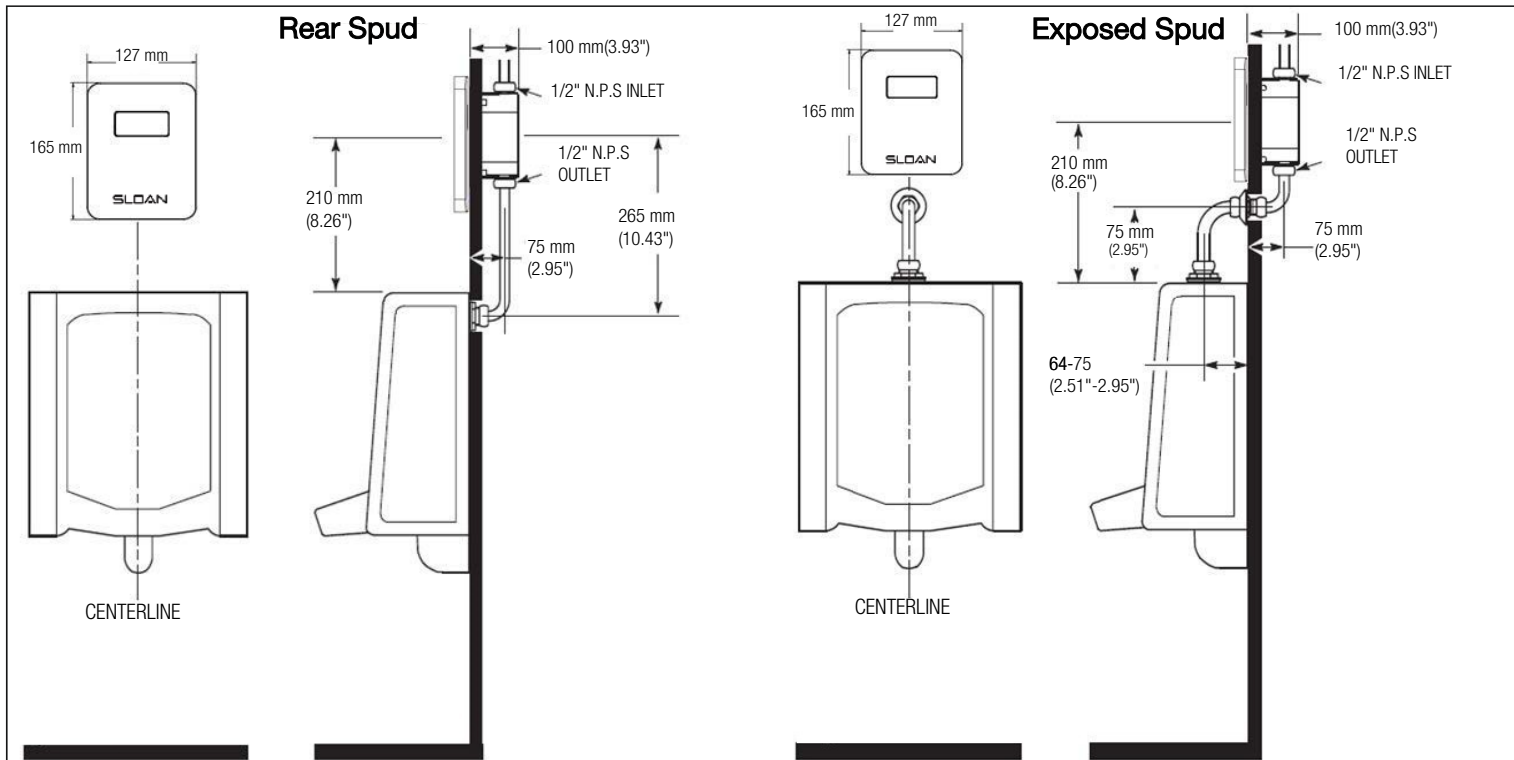

INSTALLATION SETP:-

1 Mark Plumbing Assembly Wall Box Location on Wall

- Mark location of Plumbing Assembly Wall Box on wall. Location should be centrally aligned with the urinal fixture. Make opening in wall. Refer to Rough-in diagram on Page 1

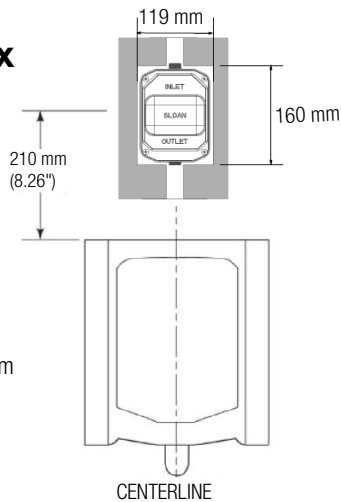

2 Line Purge

- Flush dirt, debris, and sediment from the supply line for 30 sec.

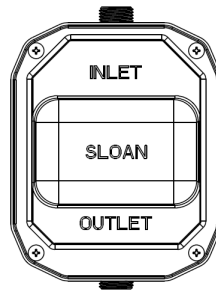

3 Connect Socket at Inlet ,Outlet & Install Wall Box in the wall within Min- to- Max mark

Note:- When installing the optional Transformer :-Run electrical line from Transformer through opening in top of plumbing Assemble Wall box

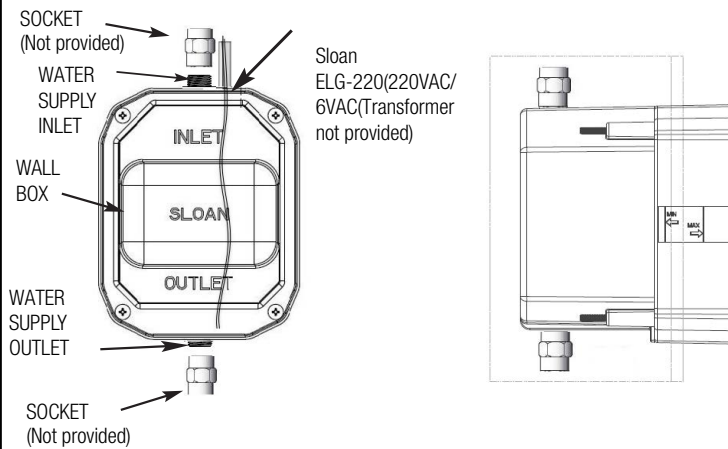

4 Connect Water Inlet- Outlet Line

- Connect supply line to inlet (top) of Plumbing Assembly Wall Box
- Connect the outlet (bottom) of Plumbing Assembly Wall Box to the inlet of urinal

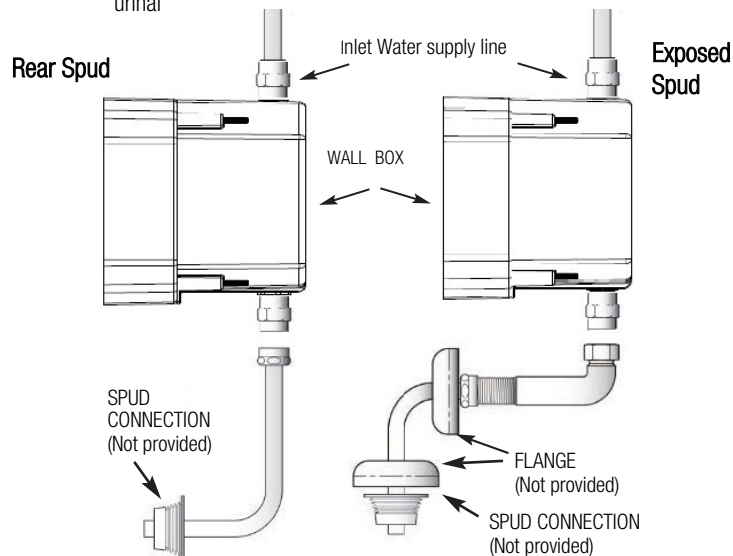

5 Level the Wall

- Check the level
- Fill the concrete around the wall box to level the surface.

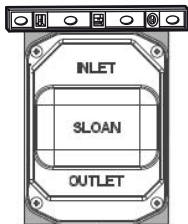

6 Finish The wall

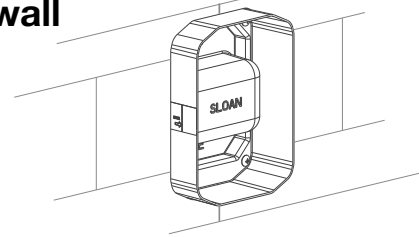

LIMITED WARRANTY

Unless otherwise noted, Sloan India Pvt. Ltd warrants this product, manufactured and sold for commercial or industrial uses, to be free from defects in material and workmanship for a period of Five (5) years and 1 Year- All Electronic & battery not covered in warranty from date of first purchase. During this period, Sloan India Pvt. Ltd will, at its option, repair, replace, or refund the purchase price of any product which fails to conform with this warranty under normal use and service. This shall be the sole and exclusive remedy under this warranty. Products must be returned to Sloan India Pvt. Ltd, at customer's cost. No claims will be allowed for labor, transportation or other costs. This warranty extends only to persons or organizations who purchase Sloan's products directly from Sloan India Pvt. Ltd for purpose of resale. This warranty does not cover the life of the batteries.

THERE ARE NO WARRANTIES WHICH EXTEND BEYOND THE DESCRIPTION ON THE FACE HEREOF. IN NO EVENT IS SLOAN VALVE COMPANY RESPONSIBLE FOR ANY CONSEQUENTIAL DAMAGES OF ANY MEASURE WHATSOEVER.

SLOAN

SLOAN INDIA PRIVATE LIMITED

344, PHASE-II UDYOG VIHAR, GURGAON 122015 Phone: (+91) 124-6013300/33

Toll Free: 1800.123.3080 | customercare@sloan.in | sloan.in | copyright © 2021 Sloan All rights reserved