

CX Sensor Flushometer

Hardwired with Battery Backup

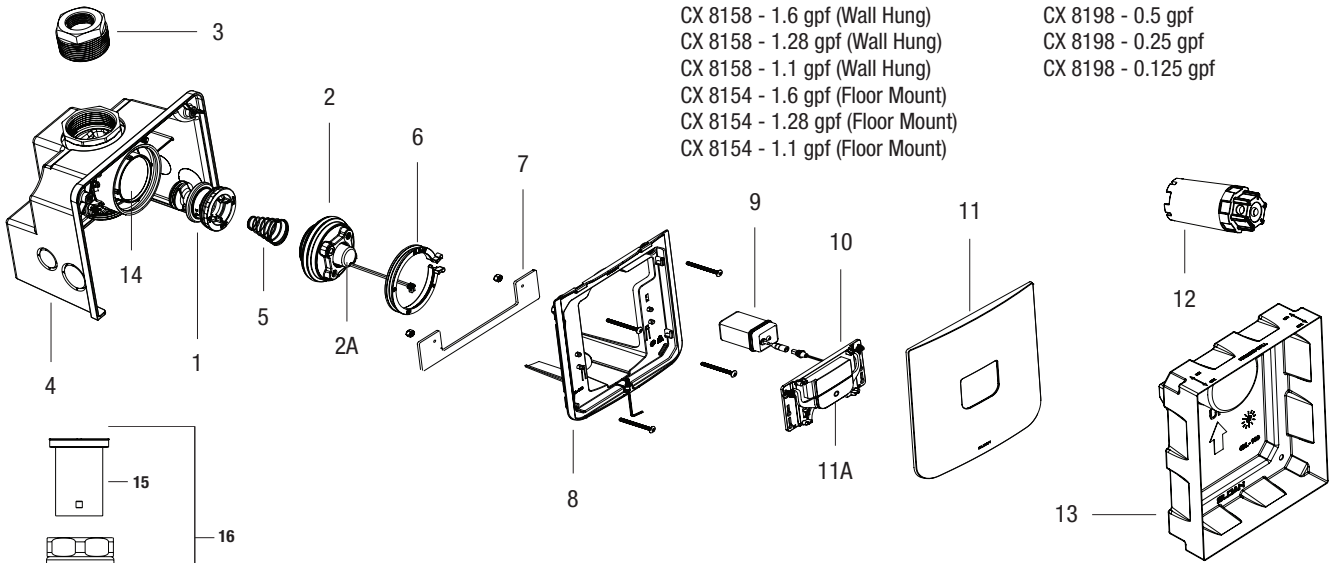

Sensor Closet Flushometers
 CX 8158 - 1.6 gpf (Wall Hung)
 CX 8158 - 1.28 gpf (Wall Hung)
 CX 8158 - 1.1 gpf (Wall Hung)
 CX 8154 - 1.6 gpf (Floor Mount)
 CX 8154 - 1.28 gpf (Floor Mount)
 CX 8154 - 1.1 gpf (Floor Mount)

Sensor Urinal Flushometers
 CX 8198 - 0.5 gpf
 CX 8198 - 0.25 gpf
 CX 8198 - 0.125 gpf

For Model 8158, Wall Hung

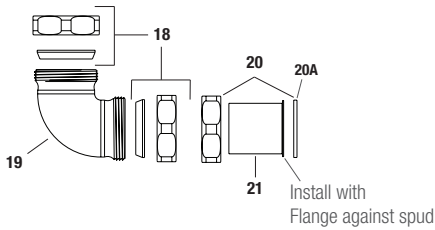

For Model 8198, Urinals

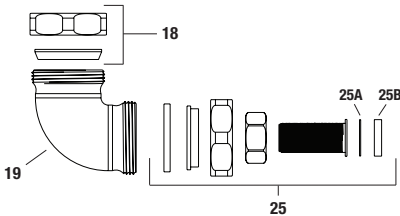

For Model 8154, Floor Mount Exposed Rear Inlet

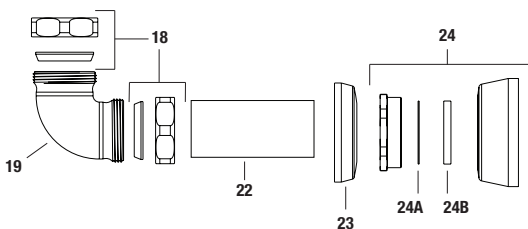

PARTS LIST

Item No.	Code No.	Part No.	Description
1	See table on next page		Piston Assembly
2	See table on next page		Activation Assembly (Includes Item 2A)
2A	See table on next page		Solenoid Assembly
3	0340062	GBL-56	Inlet Adapter 1-1/2" NPT x 1" NPT Closet
	0340063	GBL-171	Inlet Adapter 1-1/2" NPT x 3/4" NPT Urinal
4	—	—	Sensor CX Valve Body and Box Assembly*
5	—	—	Conical Spring**
6	3340011	GBL-1011-A	Safety Collar (Collar for Bonnet)
7	33400011	GBL-214-A	C-Bracket with (2) Lock Nuts and Screws
8	—	—	Sensor CX Wall Bracket*
9	9103681PK	ELG-79	Battery Pack
10	See table on next page		Sensor Assembly Closet
	See table on next page		Sensor Assembly Urinal
11	See table on next page		Finished Wall Plate
11A	See table on next page		Override Button Only
12	3340012	GBL-1012-A	Activation Assembly Tool
13	33400035	GBL-1062-A	Replacement Mud Guard, Sensor (4 pack)
14	0340085	GBL-66-A	Shut Off Sleeve (with O-Ring)

* Not sold separately. ** Included with Piston.

FLUSH CONNECTION PARTS

Item No.	Code No.	Part No.	Description
15	3323183	V-651	Vacuum Breaker Repair Kit
16	0323011	V-500-A	RB Vacuum Breaker Assembly
17	33060011	F-227-A	Adjustable Tube 6.5" Replacement Kit, 8158, 8198
	33060012	F-228-A	Adjustable Tube 10.5" Replacement Kit, 8154
18	0306395	F-211-A	CX Poly Washer and Coupling (set of 2)
19	0306392PK	F-305	CX Elbow for CX Poly Washer
20	0306091	F-2-A	1-1/2" Coupling Set with S-21 Gasket
20A	0319079	S-21	1-1/2" Rigid Gasket

CX Sensor Flushometer

Hardwired with Battery Backup

FLUSH CONNECTION PARTS CONTINUED

Item No.	Code No.	Part No.	Description
21	0306031PK	F-1	1-1/2" x 6" Tube
22	0396119PK	F-101	CP Tube Outlet 1-1/2" x 10-1/2"
23	0306237PK	F-7	Tube Flange 1-1/2" x 2-3/4" with Prongs
24	0306146	F-5-AT	1-1/2" Spud Coupling Assembly CP *
24A	5306058	F-3	Friction Ring 1-1/2"
24B	5322001	VBF-5	Slip Joint Gasket 1-1/2"
25	0306396	—	Urinal Flush Connection Repair Kit
25A	5306055	F-3	Red Friction Ring 3/4"
25B	5306113	F-5	Gasket 3/4"

ADDITIONAL PARTS

Code No.	Part No.	Description
—	F-304	Poly Washer 1-1/2" (Only available in F-211-A, Item 18)
33400019	GBL-1050-A	Sensor CX Finished Wall Plate and Button Assembly, SF†
33400021	GBL-1051-A	Sensor CX Finished Wall Plate and Button Assembly, CP†
33400022	GBL-1052-A	Sensor CX Finished Wall Plate and Button Assembly, BN†
33400023	GBL-1053-A	Sensor CX Finished Wall Plate and Button Assembly, PB†
33400024	GBL-1054-A	Sensor CX Finished Wall Plate and Button Assembly, GR†
33400025	GBL-1055-A	Sensor CX Button Only Replacement Kit, SF
33400026	GBL-1056-A	Sensor CX Button Only Replacement Kit, CP
33400027	GBL-1057-A	Sensor CX Button Only Replacement Kit, BN
33400028	GBL-1058-A	Sensor CX Button Only Replacement Kit, PB
33400029	GBL-1059-A	Sensor CX Button Only Replacement Kit, GR

† Includes mounting screws and wrench.

ITEM NO. 1 - SENSOR PISTON ASSEMBLY SELECTION GUIDE

Code No.	Part No.	Description	Piston Color*
3340053	GBL-1037-A	1.6 gpf/6.0 Lpf Closet Piston Assembly	Green
33400079	GBL-1098-A	1.28 gpf/4.8 Lpf Closet Piston Assembly	Blue/Black
33400061	GBL-1088-A	1.1 gpf/4.2 Lpf Closet Piston Assembly	Burgundy/Black
3340055	GBL-1039-A	0.5 gpf/1.9 Lpf Urinal Piston Assembly	Red
3340056	GBL-1040-A	0.25 gpf/1.0 Lpf Urinal Piston Assembly	Burgundy
33400003	—	0.125 gpf/0.48 Lpf Urinal Piston Assembly†	Red/Pink

NOTE: Item No. 1 includes Item No. 5 (Conical Spring).

* Colors may differ. Consult factory to confirm you have the correct Piston Assembly.

† 0.125 gpf/0.48 Lpf Valve Components (Piston, Main Seat, and Activation Assembly) are NOT interchangeable with any other flush volume Valves.

ITEM NO. 1 - SENSOR PISTON IDENTIFICATION CHART

Flush Volume	1.6 gpf Water Closet	1.28 gpf Water Closet	1.1 gpf Water Closet	0.5 gpf Urinal	0.25 gpf Urinal	0.125 gpf Urinal
Piston Body	Green	Light Blue	Burgundy	Red	Burgundy	Red
Flow Control	Green	Black Cage	Black Cage	Red	Burgundy	Pink
Part Number	GBL-1037-A	GBL-1098-A	GBL-1088-A	GBL-1039-A	GBL-1040-A	—
Code Number	3340053	33400079	33400061	3340055	3340056	33400003

ITEM NO. 2 - ACTIVATION ASSEMBLY SELECTION GUIDE

LEGACY CONNECTION** - PRIOR TO DECEMBER 2021

Code No.	Part No.	Description	Plug Color*
3340057	GBL-1041-A	1.6 gpf/6.0 Lpf Closet Activation Assembly, Legacy connection	Green
3340058	GBL-1042-A	1.28 gpf/4.8 Lpf Closet Activation Assembly, Legacy connection	Purple
3340059	GBL-1043-A	0.5 gpf/1.9 Lpf Urinal Activation Assembly, Legacy connection	Red
3340060	GBL-1044-A	0.25 gpf/1.0 Lpf Urinal Activation Assembly, Legacy connection	Burgundy
33400006	GBL-1070-A	0.125 gpf/0.48 Lpf Urinal Activation Assembly, Legacy connection	N/A; Nickel plated brass

PIGTAIL CONNECTION** - AFTER DECEMBER 2021

Code No.	Part No.	Description	Plug Color*
33400051	GBL-1077-A	1.6 gpf/6.0 Lpf Closet Activation Assembly, Pigtail connection	Green
33400052	GBL-1078-A	1.28 gpf/4.8 Lpf Closet Activation Assembly, Pigtail connection	Purple
33400062	GBL-1092-A	1.1 gpf/4.2 Lpf Closet Activation Assembly	Grey
33400053	GBL-1079-A	0.5 gpf/1.9 Lpf Urinal Activation Assembly, Pigtail connection	Red
33400054	GBL-1080-A	0.25 gpf/1.0 Lpf Urinal Activation Assembly, Pigtail connection	Burgundy
33400056	GBL-1081-A	0.125 gpf/0.48 Lpf Urinal Activation Assembly, Pigtail connection	N/A; Nickel plated brass

* Colors may differ. Consult factory to confirm you have the correct assembly.

** Includes Solenoid Repair Kit #2A.

ITEM NO. 2A - SOLENOID ASSEMBLY SELECTION GUIDE

Code No.	Part No.	Description
33250013	EBV-415-A	Solenoid Assembly with Legacy connection
33400078	GBL-1096-A	Solenoid Assembly with Pigtail connection

ITEM NO. 10 - SENSOR ASSEMBLY SELECTION GUIDE

Code No.	Part No.	Description
0340271	GBL-209-AC	CX Sensor Assembly for Closet with Legacy connection
0340272	GBL-210-AU	CX Sensor Assembly for Urinal with Legacy connection
33400069	GBL-219-A	CX Sensor Assembly for Closet with Pigtail connection
33400071	GBL-220-A	CX Sensor Assembly for Urinal with Pigtail connection

NOTE: After December 2021, the Activation, Solenoid, and Sensor Assembly connections were changed to a pigtail style connection.

CONNECTION TYPES

LEGACY
2 WIRE

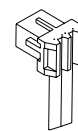

PIGTAIL

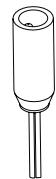

SOLENOID

PLUG

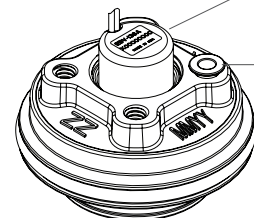

CX Sensor Flushometer

Hardwired with Battery Backup

TROUBLESHOOTING GUIDE

1. Sensor LED Flashes Continuously Only When User Steps Within Range.

- A. Unit is in start-up mode; no problem. This feature is active for the first ten (10) minutes of operation.

2. Red Light Blinks Four (4) Times When User Steps Within Range.

- A. "AA" Batteries depleted; replace batteries, lithium or alkaline. Ensure batteries are installed with proper polarity (+) and (-). **Do not mix** old and new batteries or different types.
- B. (Hardwired) Battery Box not connected; connect Battery Box to Sensor Assembly.

3. Valve Does Not Flush; Sensor Not Picking Up User.

- A. Verify a urinal Sensor is not used on a closet Valve. Model is marked on rear of Sensor.
- B. Range is too short; recalibrate range. Restart the Sensor by holding the Override Button in for 25 seconds, then release the Override Button and step away for one (1) minute; with power connected, this is considered a **Soft Reset**.
- C. For **Hard Reset** of Sensor, remove all power connections (battery and hardwire) for one (1) minute. Reconnect power and step away from front of Sensor for 3½ minutes. Then test Sensor activation by standing in front of Sensor for ten (10) seconds, then step away and wait for flush. Test push button.

4. Valve Does Not Flush; Sensor Picking Up Opposite Wall or Surface, or Only Flushes When Someone Walks By.

Red Light Flashes Continuously for First 10 Minutes Even with No One in Front of the Sensor.

- A. Verify a closet Sensor is not used on a urinal Valve. Model is marked on rear of Sensor.
- B. Range is too long; recalibrate range. Restart the Sensor by holding the Override Button in for 25 seconds, then release the Override Button and step away for one (1) minute; with power connected, this is considered a **Soft Reset**.
- C. If range needs to be manually shortened, reset the Sensor (follow Step 3B) and stand in front of the Sensor at desired range distance for one (1) minute.
- D. For **Hard Reset** of Sensor, remove all power connections (battery and hardwire) for one (1) minute. Reconnect power and step away from front of Sensor for 3½ minutes. Then test Sensor activation by standing in front of Sensor for ten (10) seconds, then step away and wait for flush. Test push button.

5. Valve Does Not Flush Even After Sensor Recalibration.

- A. Ensure water supply to Valve is turned on.
- B. Activation Assembly sleeve is in closed position. Turn counter-clockwise to open water flow. **Note:** there is approximately 1/8-turn (45°) of free spinning as the Activation Assembly engages the Shut Off Sleeve between opening and closing the Valve.
- C. Solenoid wire disconnected from Sensor. Ensure Solenoid wires are intact and Solenoid plug is connected properly.
- D. "AA" Batteries depleted; replace batteries, lithium or alkaline. Ensure batteries are installed with proper polarity (+) and (-). **Do not mix** old and new batteries or different types.
- E. Sensor Assembly malfunctioned. Disconnect power for one (1) minute, reconnect power, and check for start-up operation (flashing red LED). See Step 4D.
- F. Check Solenoid for activation (clicking noise when pressing Sensor Override Button). If no clicks are heard, then contact Technical Support.

6. Valve Does Not Shut Off.

- A. Ensure Solenoid is connected to Sensor.
- B. Supply line water pressure has dropped and is not sufficient to close the Valve. Close Activation Assembly until pressure is restored.
- C. Piston Bypass is clogged, Piston is damaged, or large debris stuck behind Piston. Turn off water at Shut Off Sleeve, release pressure, remove Safety Collar and Activation Assembly. Remove Piston and check inside Valve for large debris. Replace Piston if damaged or cleaning does not correct the problem.

7. Too Much Water to Fixture.

- A. Excessive flow pressure. Readjust Activation Assembly by turning clockwise to decrease flow pressure.
- B. Long Flush. Worn Piston; replace with new proper gpf/Lpf Piston.
- C. Wrong model installed; i.e., 1.6 gpf model installed on 0.5 gpf/1.9 Lpf or 0.25 gpf/1.0 Lpf urinal fixture. Replace with proper model per guide.

8. Not Enough Water to Fixture.

- A. Insufficient flow pressure. Readjust Activation Assembly by turning counter-clockwise to increase flow pressure.
- B. Water supply pressure is inadequate (low). Increase the water supply pressure. Contact the fixture manufacturer for minimum water supply requirements of the fixture.
- C. Wrong model installed; i.e., 0.5 gpf/1.9 Lpf urinal installed on a 1.6 gpf/6.0 Lpf closet fixture. Replace with proper model.
- D. Check lip seal for wear. Replace Piston if lip seal is worn or twisted.

9. Chirping Noise is Heard at the Start or End of Flush.

- A. Caused by air purging from the system inside the Valve Assembly. Noise will subside with several flushes or within a day.

CARE AND CLEANING

DO NOT USE abrasive or chemical cleaners (including chlorine bleach) to clean Flushometers that may dull the luster and attack the chrome or special decorative finishes. Use mild soap and water, then wipe dry with a clean soft cloth or towel. If using a cleaner in a spray bottle, **DO NOT spray directly onto the Flushometer**, instead spray cleaner into a clean cloth and then wipe down the Flushometer.

While cleaning surrounding bathroom tile, protect the Flushometer from any splattering of cleaner. Acids and abrasive cleaning fluids will discolor or remove chrome plating.

IMPORTANT NOTE FOR 1.1 GPF FLUSHOMETERS & REPLACEMENT KITS

Sloan 1.1 gpf/4.2 Lpf ultra-high efficiency flushometers meets all applicable standards and requirements. However, with low flush volumes it is imperative that they only be used in conjunction with toilet fixtures and drain line systems designed to operate with adequate flow rates and volumes in order to effectively eliminate waste and move it out of the building. It is the responsibility of the user to ensure both of these conditions are met. Not doing so may void your warranty.

Sloan 1.1 gpf diaphragm and piston kits are designed as a replacement part for Sloan 1.1 gpf/4.2 Lpf flushometers only. They are not intended to be used as a means to reduce water consumption in flushometers with higher flush volumes such as 1.28 gpf/4.8 Lpf or 1.6 gpf/6.0 Lpf or higher. Using this kit in any manner other than with a Sloan 1.1 gpf flushometer may void your warranty.

When assistance is required, please contact Sloan Technical Support at 1.888.SLOAN.14 (1.888.756.2614).